

480 VAC, 30AMP, 3PH, 60 HZ

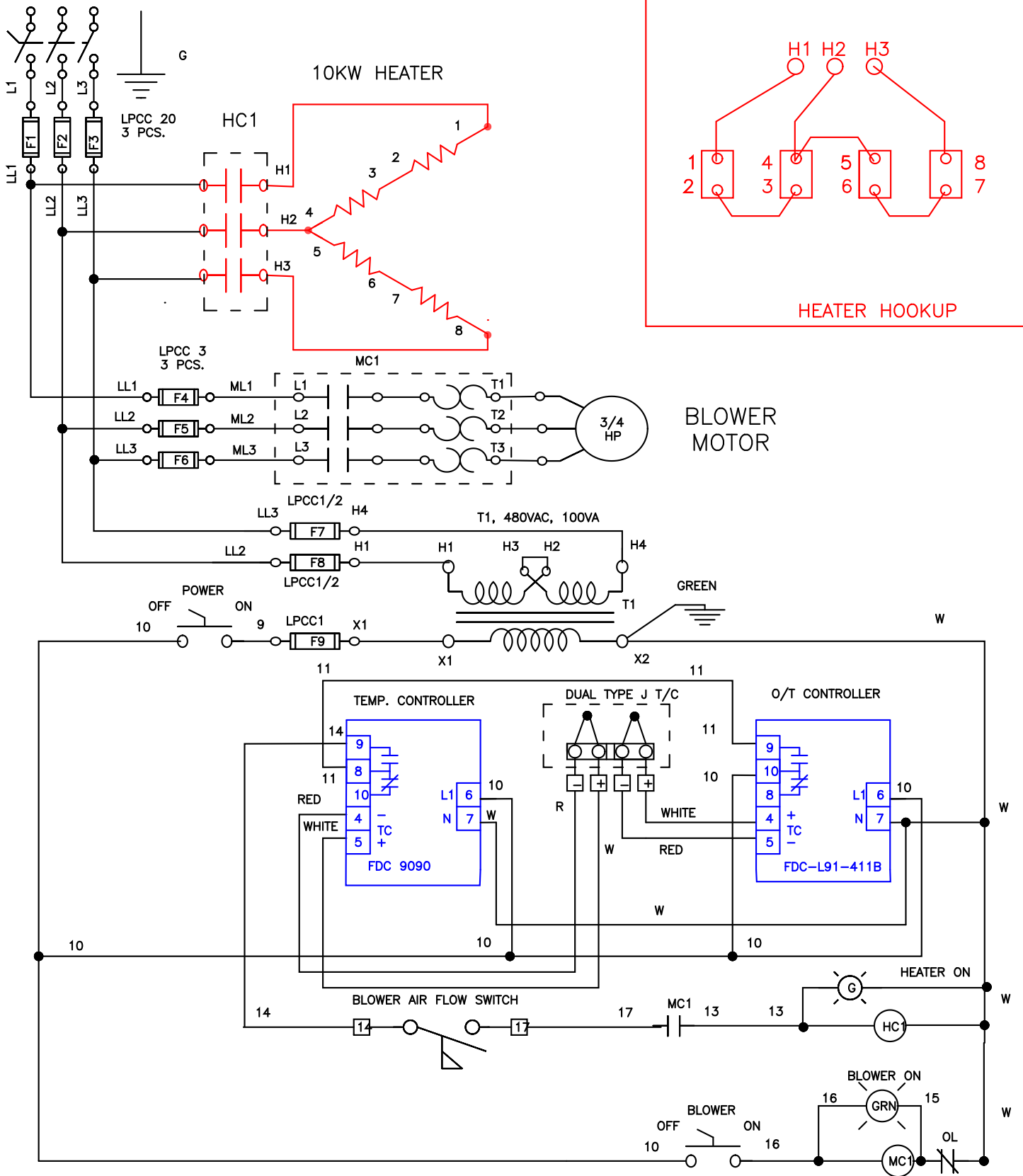

DATE:
01/31/06

BSN MEDICAL
480 VAC, 3 PH., NEMA 12

JOB NO.
J-100306

Apprvd.
R.B.

BENKO PRODUCTS INC.
5350 Evergreen Pkwy, Sheffield Village, Oh 44054